

## 5A,50-600V Superfast Rectifiers

### Features

- Low leakage current
- Low forward voltage drop
- Glass passivated chip junction
- Moisture sensitivity: level 1, per J-STD-020
- Halogen-free according to IEC 61249-2-21 definition
- High temperature soldering guaranteed: 260°C/10 seconds



**RoHS**  
COMPLIANT

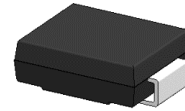

SMC (DO-214AB)

### Applications

For use in secondary rectification and freewheeling for superfast switching speeds of converters in consumer applications.

Maximum Ratings & Electrical Characteristics (T <sub>A</sub> =25°C unless otherwise noted)									
Parameter	Symbol	ES5A	ES5B	ES5C	ES5D	ES5F	ES5G	ES5J	Unit
Maximum repetitive peak reverse voltage	V <sub>RRM</sub>	50	100	150	200	300	400	600	V
Maximum RMS voltage	V <sub>RMS</sub>	35	70	105	140	210	280	420	V
Maximum DC blocking voltage	V <sub>DC</sub>	50	100	150	200	300	400	600	V
Maximum average forward rectified current	I <sub>F(AV)</sub>	5							A
Peak forward surge current, 8.3ms single half sine-wave superimposed on rated load per diode	I <sub>FSM</sub>	150							A
Operating junction temperature range	T <sub>J</sub>	-55 to +150							°C
Storage temperature range	T <sub>STG</sub>	-55 to +150							°C

Thermal-Mechanical Specifications (T <sub>A</sub> =25°C unless otherwise noted)			
Parameter	Symbol	Typ	Unit
Thermal Resistance, Junction to Ambient	R <sub>θJA</sub>	65	°C / W
Thermal Resistance, Junction to Case	R <sub>θJC</sub>	10	°C / W
Thermal Resistance, Junction to Lead	R <sub>θJL</sub>	15	°C / W

## Electrical Specifications (T<sub>A</sub>=25°C unless otherwise noted)

Parameter	Symbol	Test Conditions	ES5A	ES5B	ES5C	ES5D	ES5F	ES5G	ES5J	Unit
Forward Drop Voltage	V <sub>F</sub>	I <sub>F</sub> =5A T <sub>A</sub> =25°C	0.95				1.40		1.70	V
		I <sub>F</sub> =5A T <sub>A</sub> =125°C	0.75				1.05		1.25	
Reverse leakage current @V <sub>R</sub>	I <sub>R</sub>	T <sub>J</sub> =25°C	5							uA
		T <sub>J</sub> =125°C	100							
Typical junction capacitance	C <sub>J</sub>	4.0 V 1 MHz	95.3				100.4		52.6	pF
Maximum reverse recovery time	t <sub>rr</sub>	I <sub>F</sub> =0.5A, I <sub>R</sub> =1.0A, I <sub>RR</sub> =0.25A	35							nS

Note:

1. Mounted on copper pad area of 8.0 x 8.0mm to each terminal.

## Ratings and Characteristics Curves

( $T_A = 25^\circ\text{C}$  unless otherwise noted)

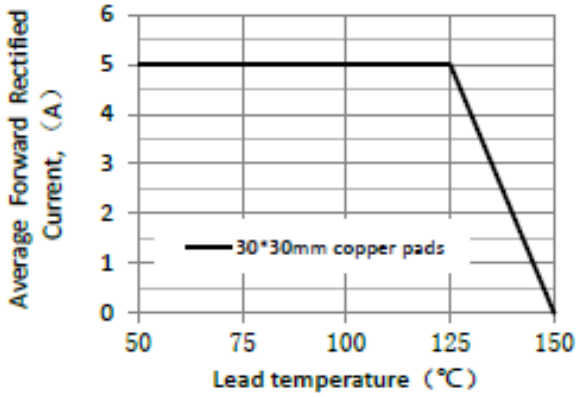

Figure 1. Forward Current Derating Curve

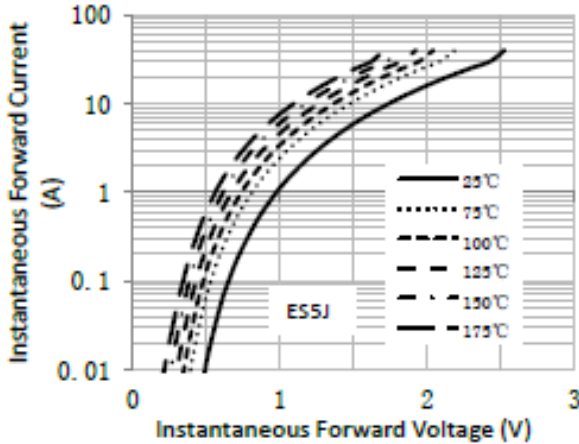

Figure 3. Typical Instantaneous Forward Characteristics

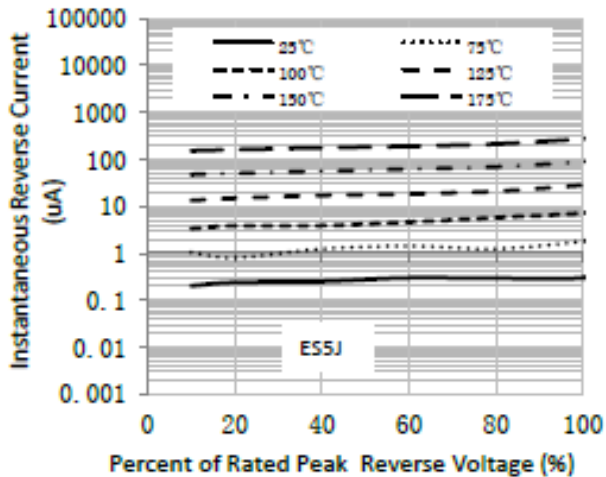

Figure 5. Typical Reverse Characteristics

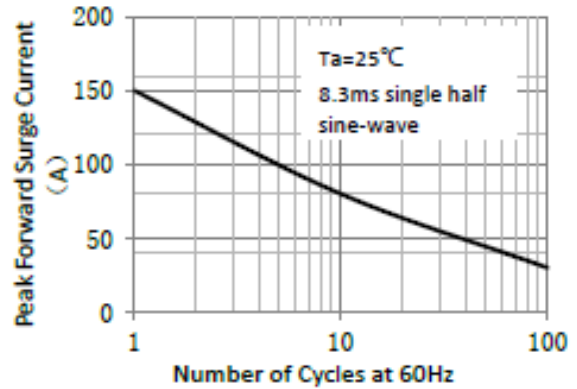

Figure 2. Maximum Non-Repetitive Peak Forward Surge Current

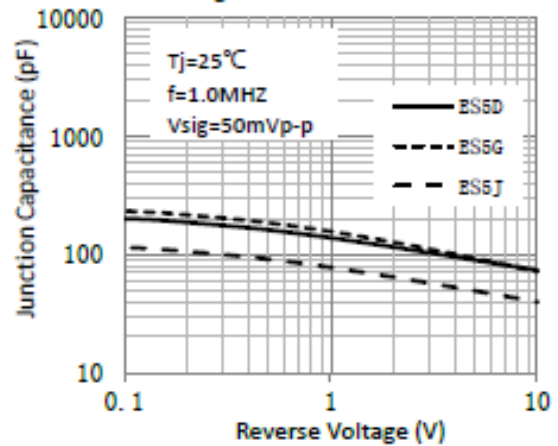

Figure 4. Typical Junction Capacitance

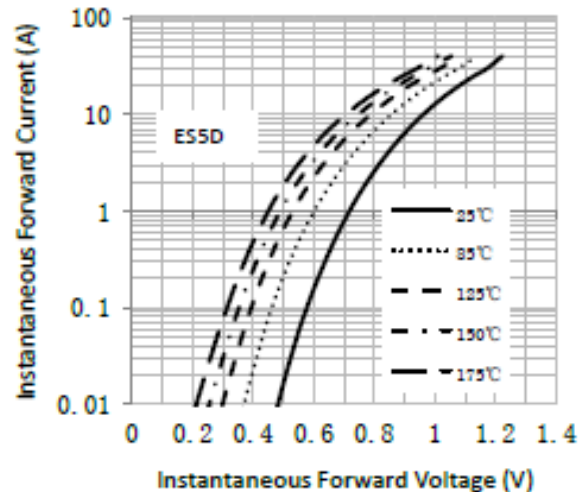

Figure 6. Typical Instantaneous Forward Characteristics

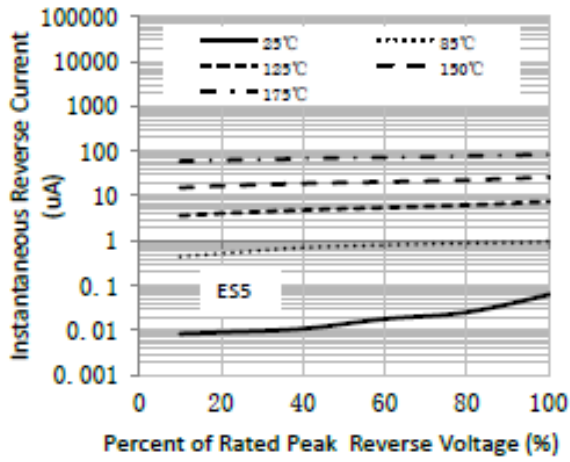

Figure 7. Typical Reverse Characteristics

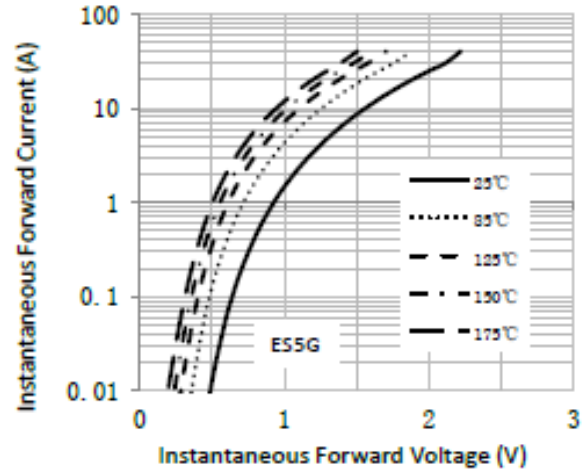

Figure 8. Typical Instantaneous Forward Characteristics

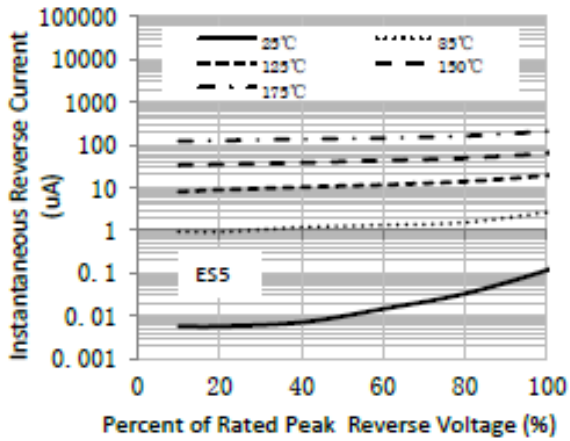
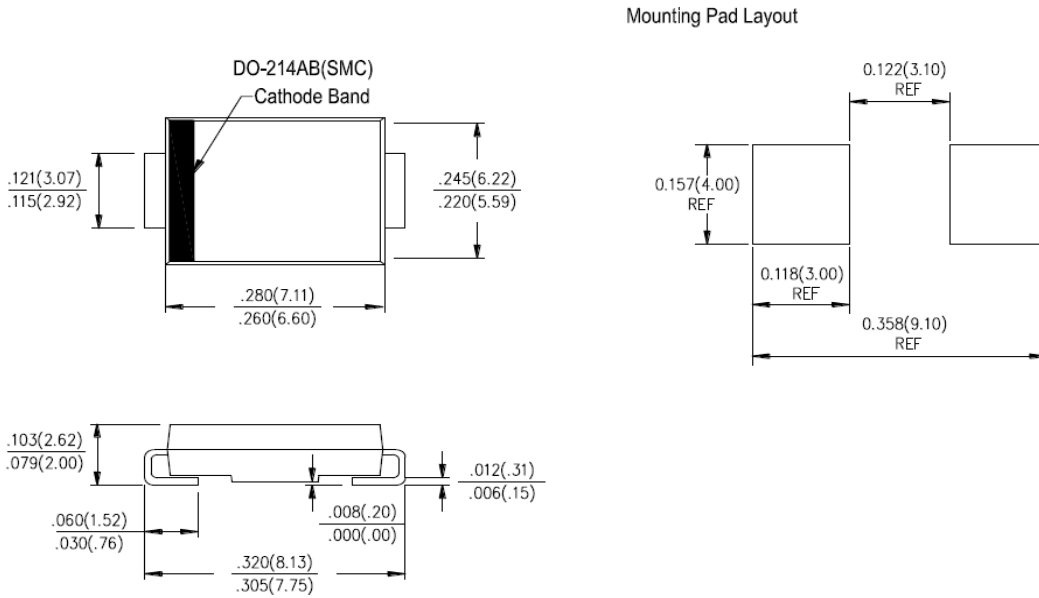

Figure 9. Typical Reverse Characteristics

## Package Outline Dimensions

in inches (millimeters)

### SMC (DO-214AB)



## Revision History

Document Version	Date of release	Description of changes
Rev.A	2021.06.01	Released Datasheet
Rev.B	2023.10.20	Modify document format

## Disclaimers

These materials are intended as a reference to assist our customers in the selection of the Suzhou Good-Ark product best suited to the customer's application; they do not convey any license under any intellectual property rights, or any other rights, belonging to Suzhou Good-Ark Electronics Co., Ltd. or a third party.

Suzhou Good-Ark Electronics Co., Ltd. assumes no responsibility for any damage, or infringement of any third-party's rights, originating in the use of any product data, diagrams, charts, programs, algorithms, or circuit application examples contained in these materials.

All information contained in these materials, including product data, diagrams, charts, programs and algorithms represents information on products at the time of publication of these materials, and are subject to change by Suzhou Good-Ark Electronics Co., Ltd. without notice due to product improvements or other reasons. It is therefore recommended that customers contact Suzhou Good-Ark Electronics Co., Ltd. or an authorized Suzhou Good-Ark Electronics Co., Ltd. for the latest product information before purchasing a product listed herein. The information described here may contain technical inaccuracies or typographical errors. Suzhou Good-Ark Electronics Co., Ltd. assumes no responsibility for any damage, liability, or other loss rising from these inaccuracies or errors. Please also pay attention to information published by Suzhou Good-Ark Electronics Co., Ltd. by various means, including our website home page.

(<http://www.goodark.com>)

When using any or all of the information contained in these materials, including product data, diagrams, charts, programs, and algorithms, Please be sure to evaluate all information as a total system before making a final decision on the applicability of the information and products. Suzhou Good-Ark Electronics Co., Ltd. assumes no responsibility for any damage, liability or other loss resulting from the information contained herein.

The prior written approval of Suzhou Good-Ark Electronics Co., Ltd. is necessary to reprint or reproduce in whole or in part these materials.

Please contact Suzhou Good-Ark Electronics Co., Ltd. or an authorized distributor for further details on these materials or the products contained herein.